

Article number: 586PLL34

Description: Mini Push-in PLL34, angle, M3 hose Ø4

Measures

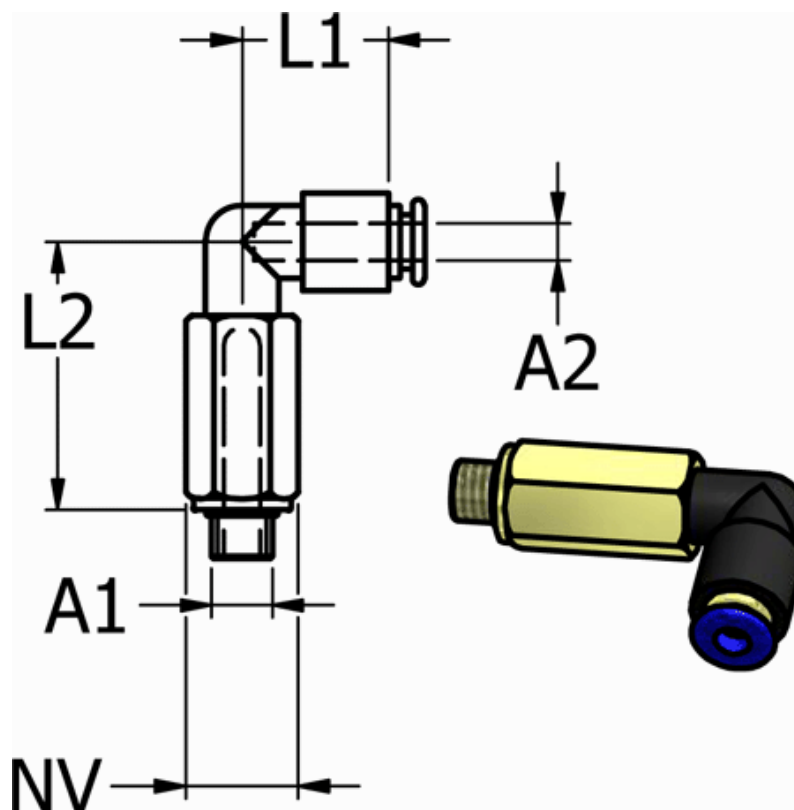

Ext. hose diameter A2 = 4 mm

L1 = 28

L2 = 17.2

NV = 8

Thread A1 = M3